

Features

- Output voltage 5 V \pm 2%
- Ultra low current consumption: typ. 20 μ A
- 300 mA current capability
- Inhibit input
- Very low-drop voltage
- Short-circuit-proof
- Suitable for use in automotive electronics

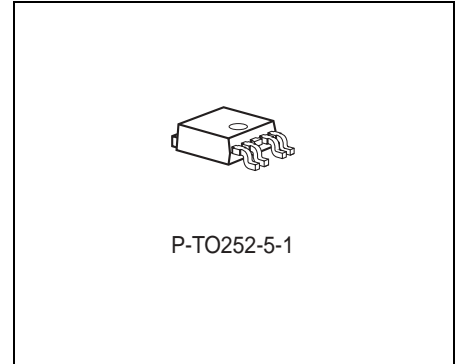

Functional Description

The TLE 7276 is a monolithic integrated low-drop voltage regulator for load currents up to 300 mA. An input voltage up to 42 V is regulated to $V_{Q,nom} = 5.0$ V with a precision of \pm 2%. The sophisticated design allows to achieve stable operation even with ceramic output capacitors down to 470 nF. The device is designed for the harsh environment of automotive applications. Therefore it is protected against overload, short circuit and overtemperature conditions. Of course the

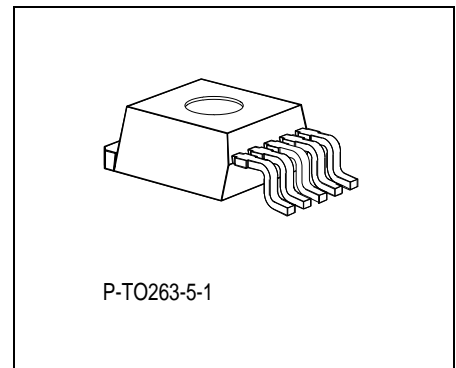

TLE 7276 can be used also in all other applications, where a stabilized 5 V voltage is required. Due to its ultra low stand-by current consumption of typ. 20 μ A the TLE 7276 is dedicated for use in applications permanently connected to V_{BAT} . The regulator can be shut down via an Inhibit input. An integrated output sink current circuitry keeps the voltage at the Output pin Q below 5.5 V even when reverse currents are applied. Thus connected devices are protected from overvoltage damage.

For applications requiring extremely low noise levels the Infineon voltage regulator family TLE 42XY and TLE 44XY is more suited than the TLE 7276. A mV-range output noise on the TLE 7276 caused by the charge pump operation is unavoidable due to the ultra low quiescent current concept.

Type	Ordering Code	Package
TLE 7276 D	Q67006-A9733	P-TO252-5-1, P-TO252-5-11
TLE 7276 G	Q67006-A9732	P-TO263-5-1

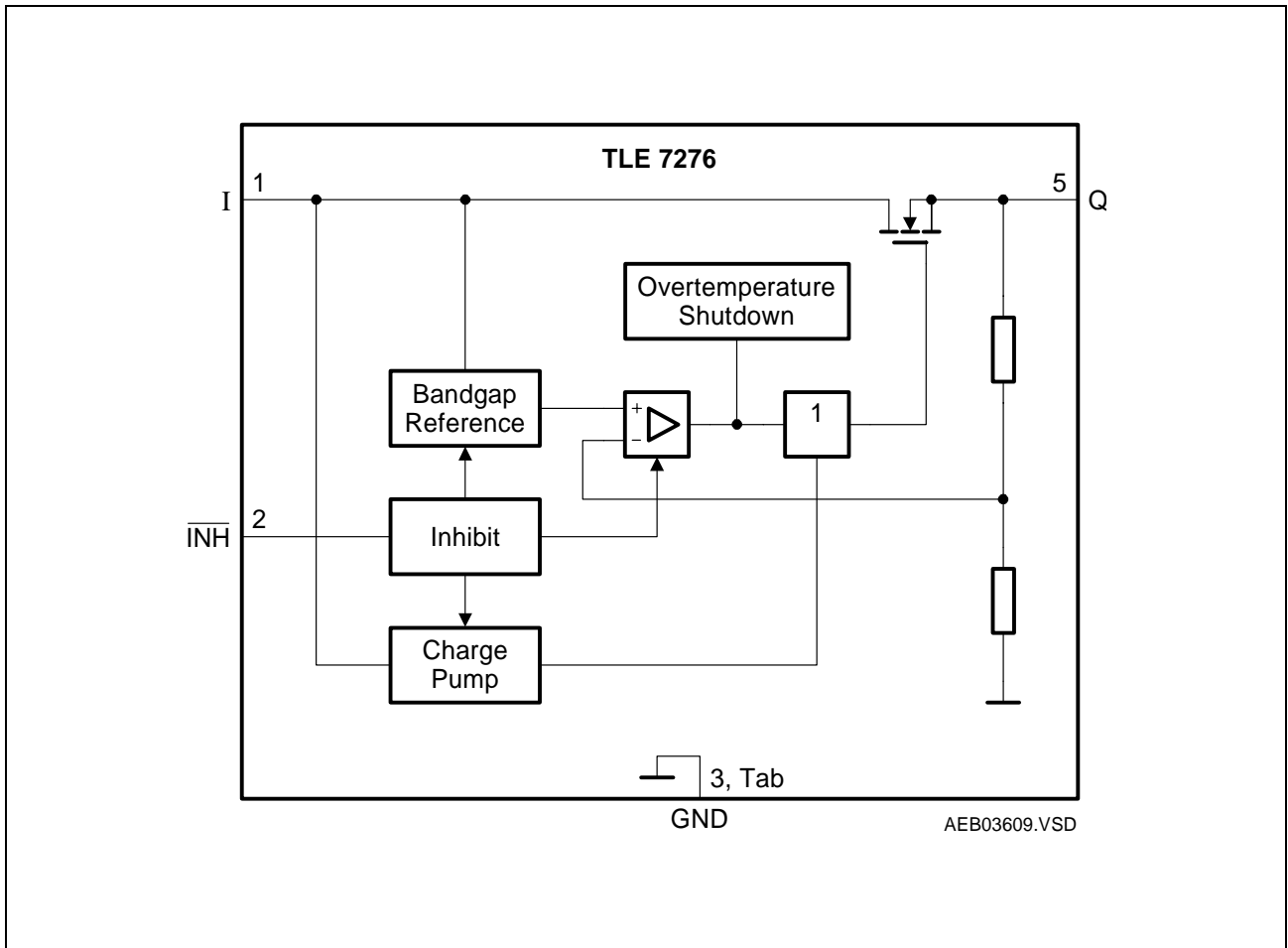

Figure 1 Block Diagram

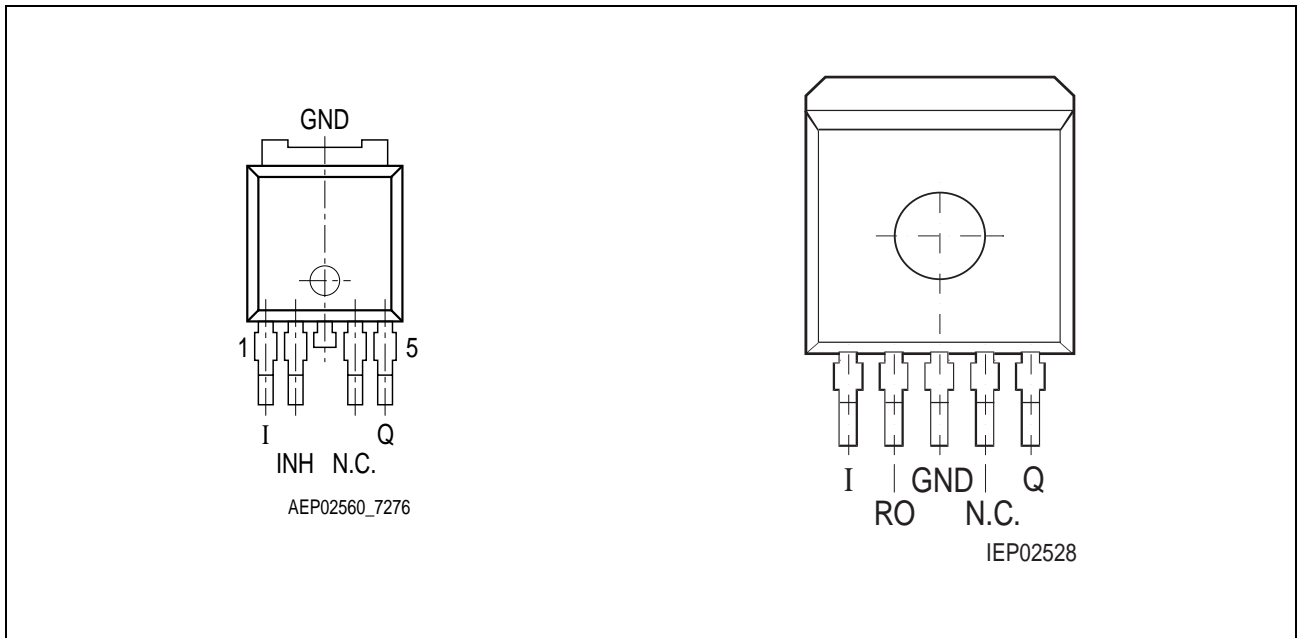

Figure 2 Pin Configuration P-TO252-5 (D-PAK), P-TO263-5 (D²-PAK)(top view)

Table 1 Pin Definitions and Functions

Pin No.	Symbol	Function
1	I	Input ; block to ground directly at the IC with a ceramic capacitor
2	$\overline{\text{INH}}$	Inhibit Input ; low level disables the IC. Integrated pull-down resistor
3	GND	Ground ; internally connected to heat sink
4	N.C.	Not connected
5	Q	Output ; block to ground with a ceramic capacitor, $C \geq 470 \text{ nF}$

Table 2 Absolute Maximum Ratings

Parameter	Symbol	Limit Values		Unit	Test Condition
		Min.	Max.		
Input I					
Voltage	V_I	-0.3	45	V	–
Current	I_I	-1	–	mA	–
Inhibit \overline{INH}					
Voltage	$V_{\overline{INH}}$	-0.3	45	V	Observe current limit $I_{\overline{INH},max}^{1)}$
Current	$I_{\overline{INH}}$	-1	1	mA	–
Output Q					
Voltage	V_Q	-0.3	5.5	V	–
Voltage	V_Q	-0.3	6.2	V	$t < 10 \text{ s}^2)$
Current	I_Q	-1	–	mA	–
Temperature					
Junction temperature	T_j	-40	150	°C	–
Storage temperature	T_{stg}	-50	150	°C	–

1) External resistor required to keep current below absolute maximum rating when voltages $\geq 5.5 \text{ V}$ are applied.

2) Exposure to these absolute maximum ratings for extended periods ($t > 10 \text{ s}$) may affect device reliability.

Note: Stresses above those listed here may cause permanent damage to the device. Exposure to absolute maximum rating conditions for extended periods may affect device reliability.

Table 3 Operating Range

Parameter	Symbol	Limit Values		Unit	Remarks
		Min.	Max.		
Input voltage	V_I	5.5	42	V	–
Junction temperature	T_j	-40	150	°C	–

Table 4 Thermal Resistance

Parameter	Symbol	Limit Values		Unit	Remarks
		Min.	Max.		
Junction case	R_{thj-c}	–	8	K/W	–
Junction ambient	R_{thj-a}	–	80	K/W	TO252 ¹⁾
Junction ambient	R_{thj-a}	–	55	K/W	TO263 ²⁾

1) Worst case, regarding peak temperature; zero airflow; mounted on a PCB FR4, 80 × 80 × 1.5 mm³, heat sink area 300 mm²

2) Worst case, regarding peak temperature; zero airflow; mounted on a PCB FR4, 80 × 80 × 1.5 mm³, heat sink area 300 mm²

Note: In the operating range, the functions given in the circuit description are fulfilled.

Table 5 Electrical Characteristics
 $V_I = 13.5 \text{ V}; V_{\overline{\text{INH}}} = 5 \text{ V}; -40 \text{ }^\circ\text{C} < T_j < 150 \text{ }^\circ\text{C}$ (unless otherwise specified)

Parameter	Symbol	Limit Values			Unit	Measuring Condition
		Min.	Typ.	Max.		
Output Q						
Output voltage	V_Q	4.9	5.0	5.1	V	$0.1 \text{ mA} < I_Q < 300 \text{ mA};$ $6 \text{ V} < V_I < 16 \text{ V}$
Output voltage	V_Q	4.9	5.0	5.1	V	$0.1 \text{ mA} < I_Q < 100 \text{ mA};$ $6 \text{ V} < V_I < 40 \text{ V}$
Output current limitation	I_Q	320	–	–	mA	1)
Output current limitation	I_Q	–	–	800	mA	$V_Q = 0 \text{ V}$
Current consumption; $I_q = I_I - I_Q$	I_q	–	20	30	μA	$I_Q = 0.1 \text{ mA};$ $T_j = 25 \text{ }^\circ\text{C}$
Current consumption; $I_q = I_I - I_Q$	I_q	–	–	40	μA	$I_Q = 0.1 \text{ mA};$ $T_j \leq 80 \text{ }^\circ\text{C}$
Quiescent current; inhibited	I_q	–	5	9	μA	$V_{\overline{\text{INH}}} = 0 \text{ V};$ $T_j < 80 \text{ }^\circ\text{C}$
Drop voltage	V_{dr}	–	250	500	mV	$I_Q = 200 \text{ mA};$ $V_{\text{dr}} = V_I - V_Q$ 1)
Load regulation	$\Delta V_{Q, \text{lo}}$	-40	15	40	mV	$I_Q = 5 \text{ mA to } 250 \text{ mA}$
Line regulation	$\Delta V_{Q, \text{li}}$	-20	5	20	mV	$V_I = 10 \text{ V to } 32 \text{ V};$ $I_Q = 5 \text{ mA}$
Power supply ripple rejection	$PSRR$	–	60	–	dB	$f_r = 100 \text{ Hz};$ $V_r = 0.5 \text{ Vpp}$
Temperature output voltage drift	dV_Q/dT	–	0.5	–	mV/K	–
Output Capacitor	C_Q	470	–	–	nF	$\text{ESR} < 3 \text{ Ohm}$
Inhibit Input $\overline{\text{INH}}$						
Turn-on Voltage	$V_{\overline{\text{INH}} \text{ ON}}$	3.1	–	–	V	$V_Q \geq 4.9 \text{ V}$
Turn-off Voltage	$V_{\overline{\text{INH}} \text{ OFF}}$	–	–	0.8	V	$V_Q \leq 0.3 \text{ V}$
H-input current	$I_{\overline{\text{INH}} \text{ ON}}$	–	3	4	μA	$V_{\overline{\text{INH}}} = 5 \text{ V}$
L-input current	$I_{\overline{\text{INH}} \text{ OFF}}$	–	0.5	1	μA	$V_{\overline{\text{INH}}} = 0 \text{ V};$ $T_j < 80 \text{ }^\circ\text{C}$

1) Measured when the output voltage V_Q has dropped 100 mV from the nominal value obtained at $V_I = 13.5 \text{ V}$.

Application Information

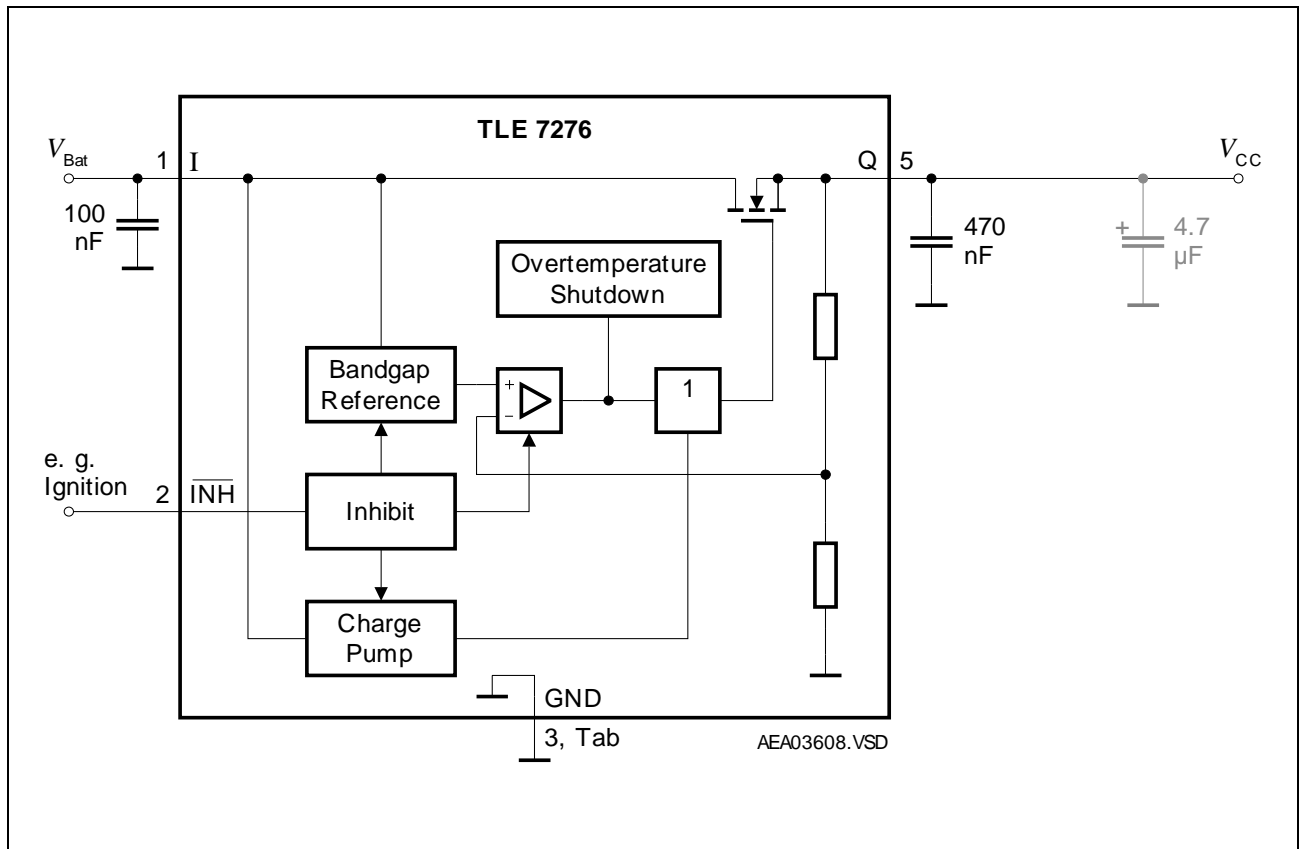

Figure 3 Application Diagram

Input, Output

An input capacitor is necessary for damping line influences. A resistor of approx. 1 Ω in series with C_i , can damp the LC of the input inductivity and the input capacitor.

In contrast to most low drop voltage regulators the TLE 7276 only needs moderate capacitance at the output to assure stability of the regulation loop. This offers more design flexibility to the circuit designer providing for cost efficient solutions.

The TLE 7276 requires a ceramic output capacitor of at least 470 nF. In order to damp influences resulting from load current surges it is recommended to add an additional electrolytic capacitor of 4.7 μF to 47 μF at the output as shown in **Figure 3**.

Additionally a buffer capacitor C_B of $> 10\mu\text{F}$ should be used for the output to suppress influences from load surges to the voltage levels. This one can either be an aluminum electrolytic capacitor or a tantalum capacitor following the application requirements.

A general recommendation is to keep the drop over the equivalent serial resistor (ESR) together with the discharge of the blocking capacitor below the allowed Headroom of the Application to be supplied (e.g. typ. $dV_Q = 350\text{mV}$).

Since the regulator output current roughly rises linearly with time the discharge of the capacitor can be calculated as follows:

$$dV_{C_B} = dI_Q \cdot dt / C_B$$

The drop across the ESR calculates as:

$$dV_{\text{ESR}} = dI \cdot \text{ESR}$$

To prevent a reset the following relationship must be fulfilled:

$$dV_C + dV_{\text{ESR}} < V_{\text{RH}} = 350\text{mV}$$

Example: Assuming a load current change of $dI_Q = 100\text{mA}$, a blocking capacitor of $C_B = 22\mu\text{F}$ and a typical regulator reaction time under normal operating conditions of $dt \sim 25\mu\text{s}$ and for special dynamic load conditions, such as load step from very low base load, a reaction time of $dt \sim 75\mu\text{s}$.

$$dV_C = dI_Q \cdot dt / C_B = 100\text{mA} \cdot 25\mu\text{s} / 22\mu\text{F} = 113\text{mV}$$

So for the ESR we can allow

$$dV_{\text{ESR}} = V_{\text{RH2}} - dV_C = 350\text{mV} - 113\text{mV} = 236\text{mV}$$

The permissible ESR becomes:

$$\text{ESR} = dV_{\text{ESR}} / dI_Q = 236\text{mV} / 100\text{mA} = 2.36\Omega$$

During design-in of the TLE7469 product family, special care needs to be taken with regards to the regulators reaction time to sudden load current changes starting from very low pre-load as well as cyclic load changes. The application note "*TLE7x Voltage Regulators - Application Note about Transient Response at ultra low quiescent current Voltage Regulators*" (see 3_cip05405.pdf) gives important hints for successful design-in of the Voltage Regulators of the TLE7x family.

Typical Performance Characteristics

Current Consumption I_q versus Junction Temperature T_j

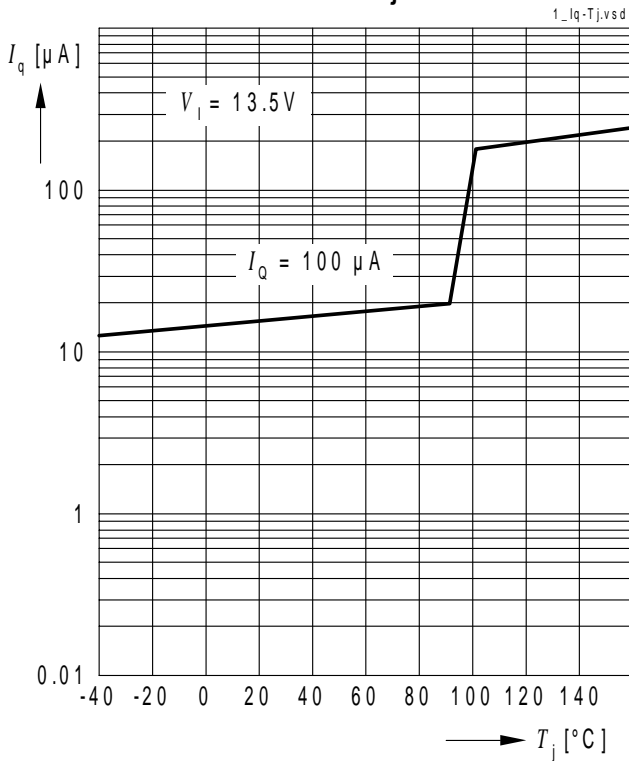

Current Consumption I_q versus Input Voltage V_i

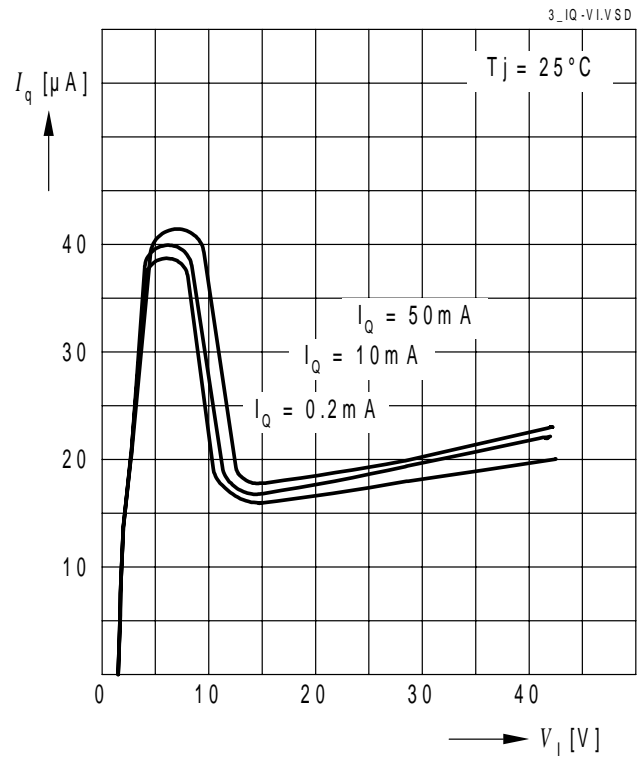

Current Consumption I_q versus Output Current I_Q

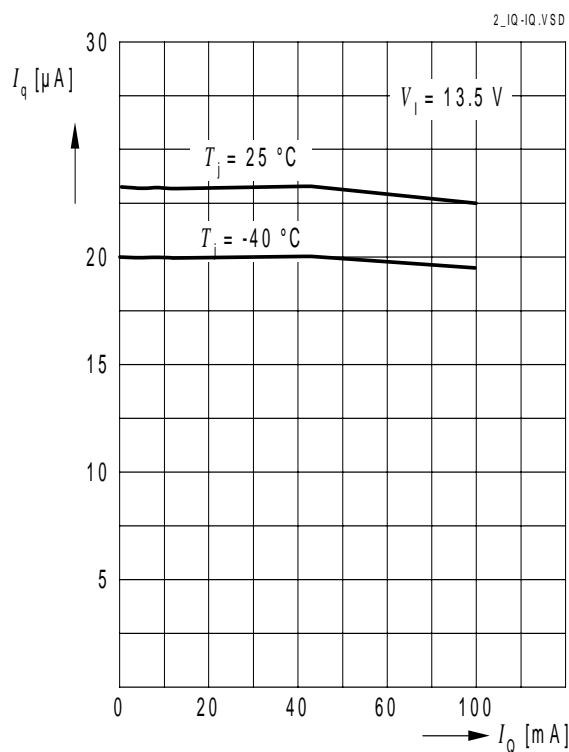

Output Voltage V_Q versus Junction Temperature T_j

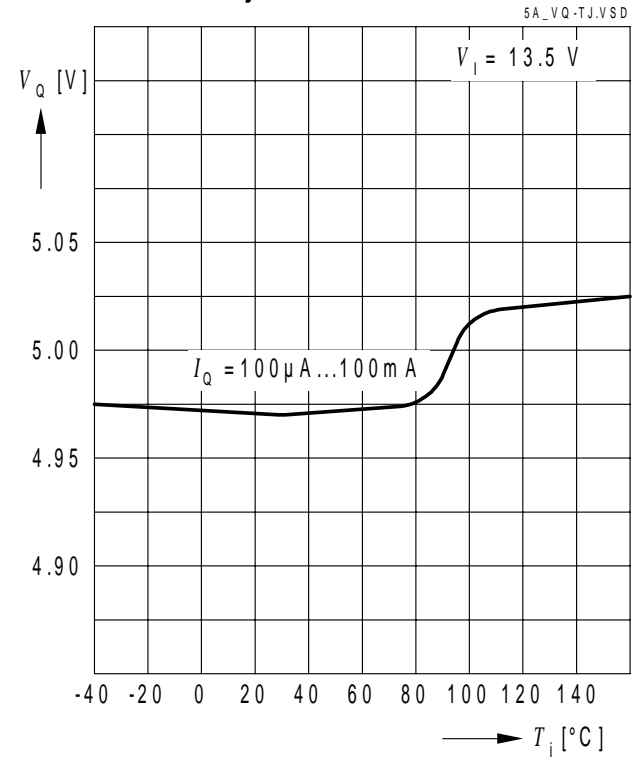

Dropout Voltage V_{dr} versus Output Current I_Q

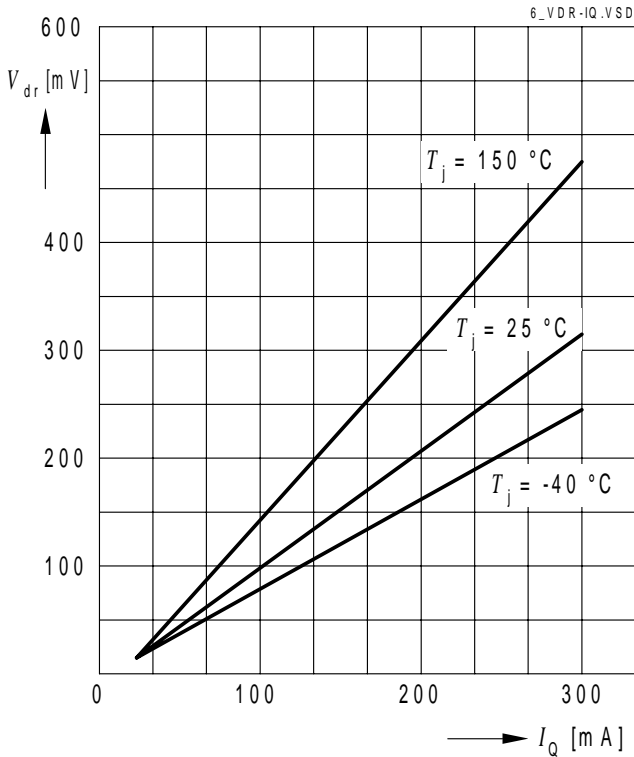

Maximum Output Current I_Q versus Junction Temperature T_j

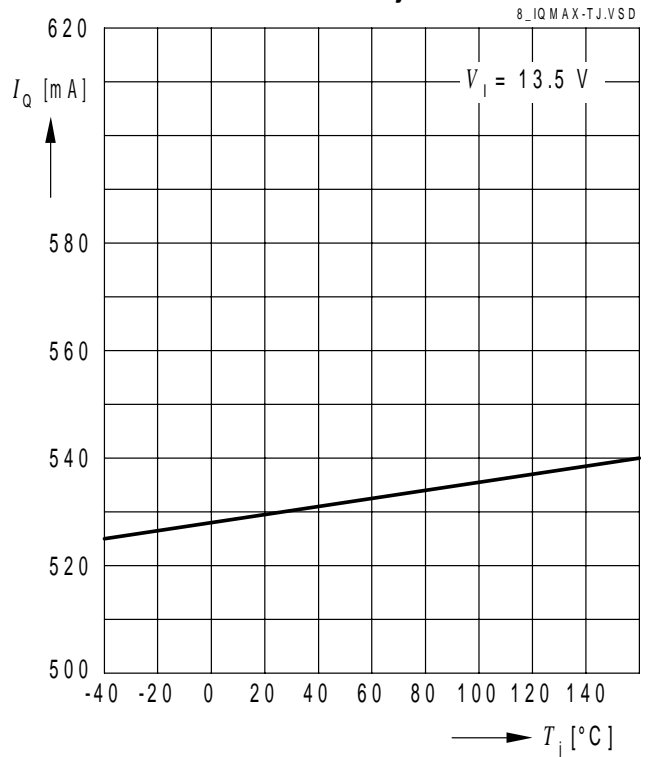

Dropout Voltage V_{dr} versus Junction Temperature T_j

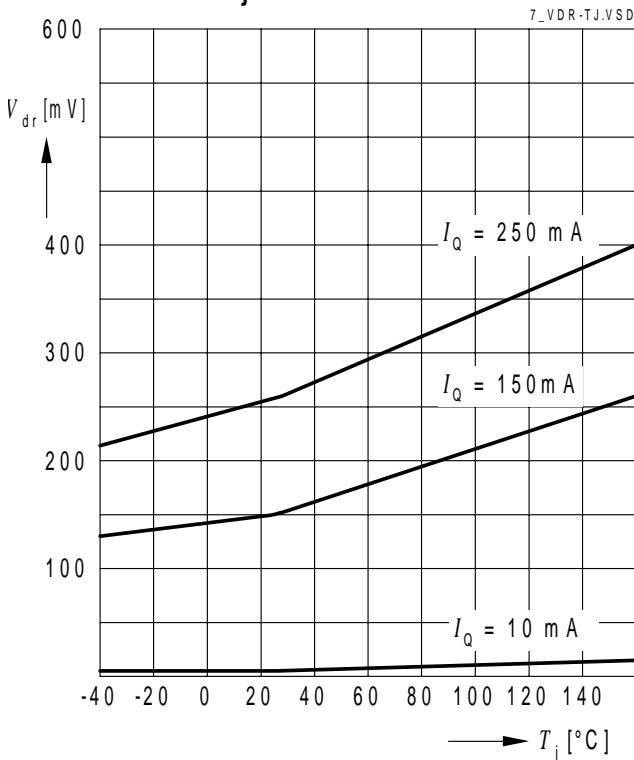

Maximum Output Current I_Q versus Input Voltage V_I

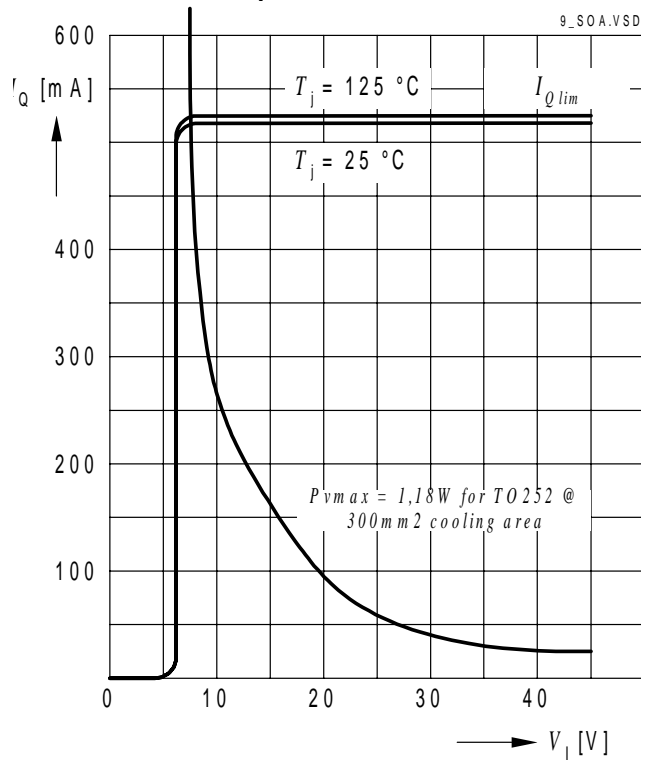

Region of Stability

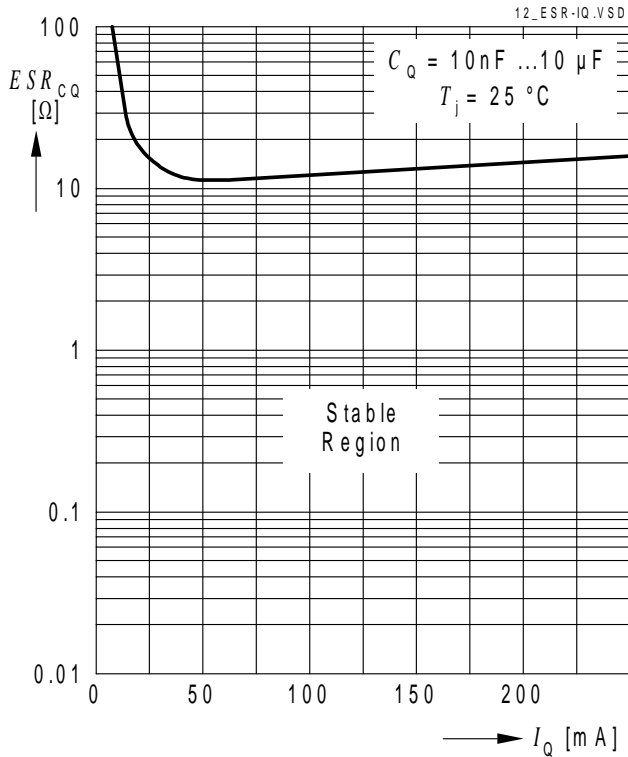

Output Voltage V_Q Start-up behaviour

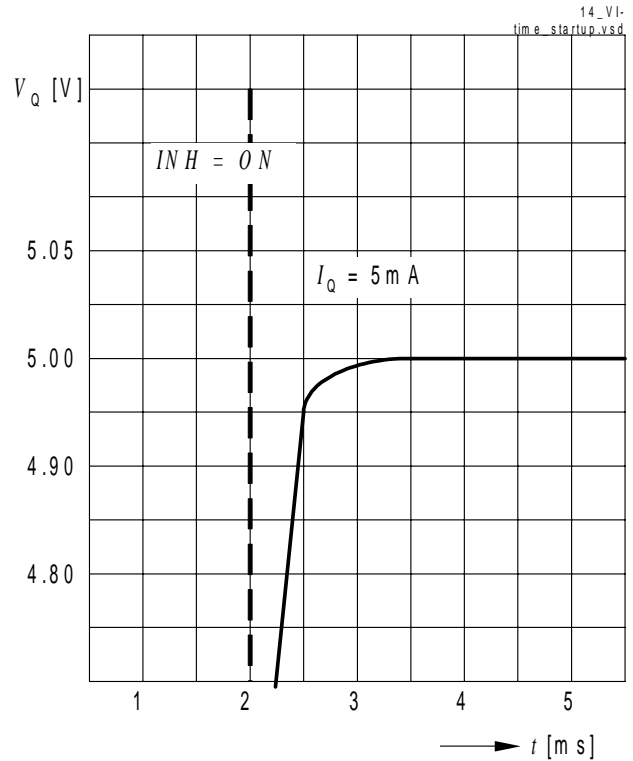

Power Supply Ripple Rejection PSRR versus Frequency f

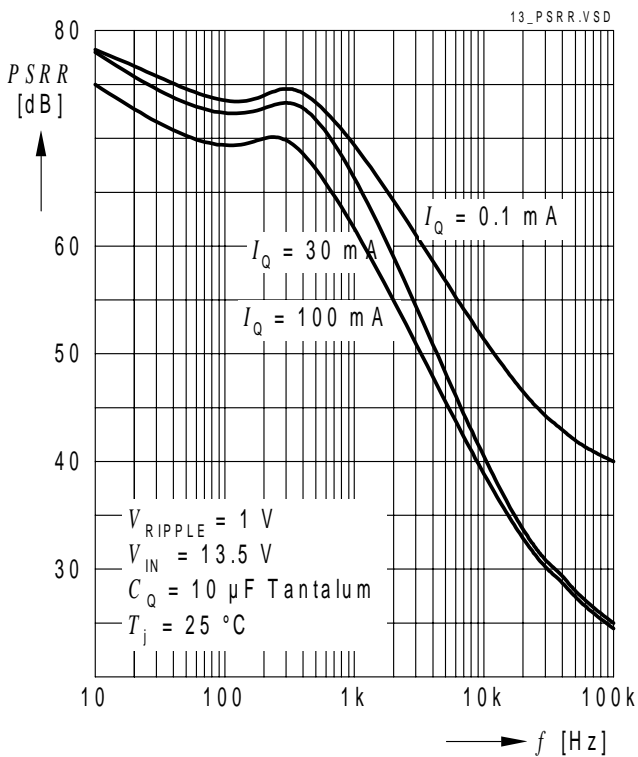

Load Regulation dV_Q versus Output Current Change dI_Q

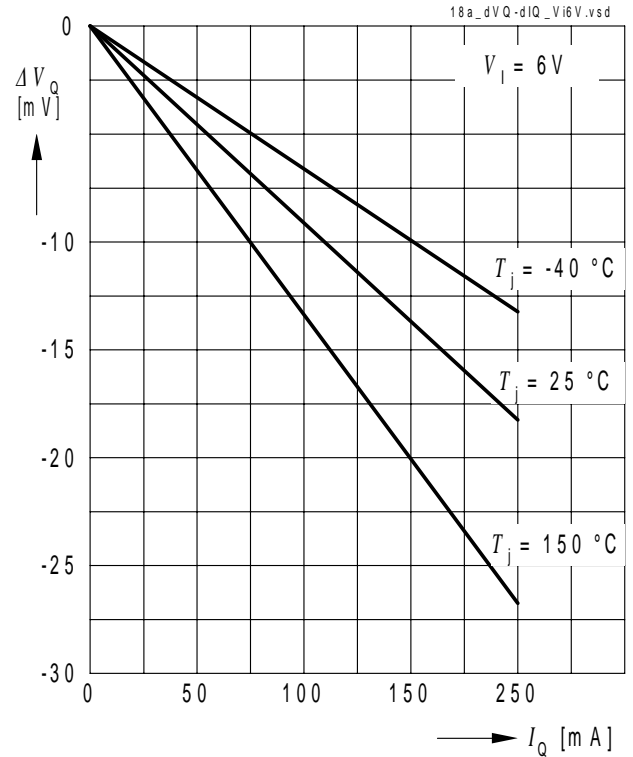

Load Regulation dV_Q versus Output Current Change dI_Q

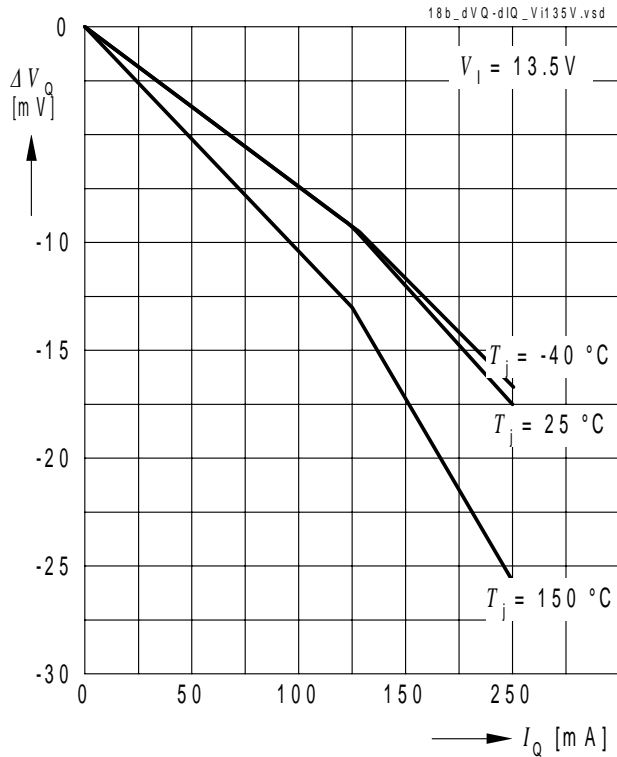

Line Regulation dV_Q versus Input Voltage Changed V_I

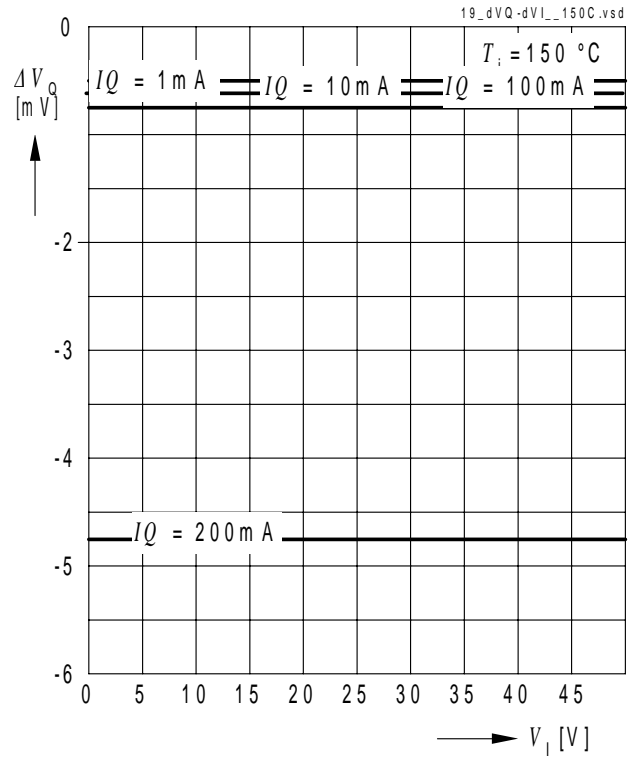

Load Regulation dV_Q versus Output Current Change dI_Q

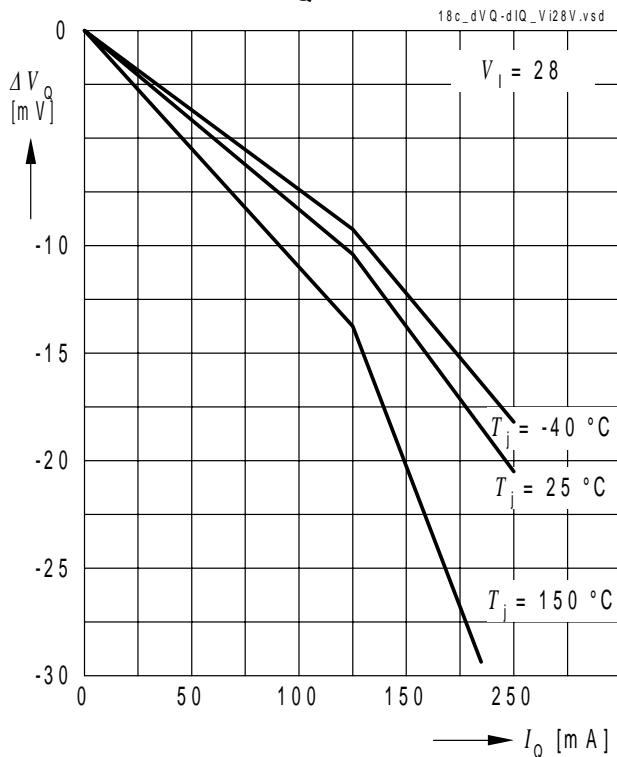

Line Regulation dV_Q versus Input Voltage Changed V_I

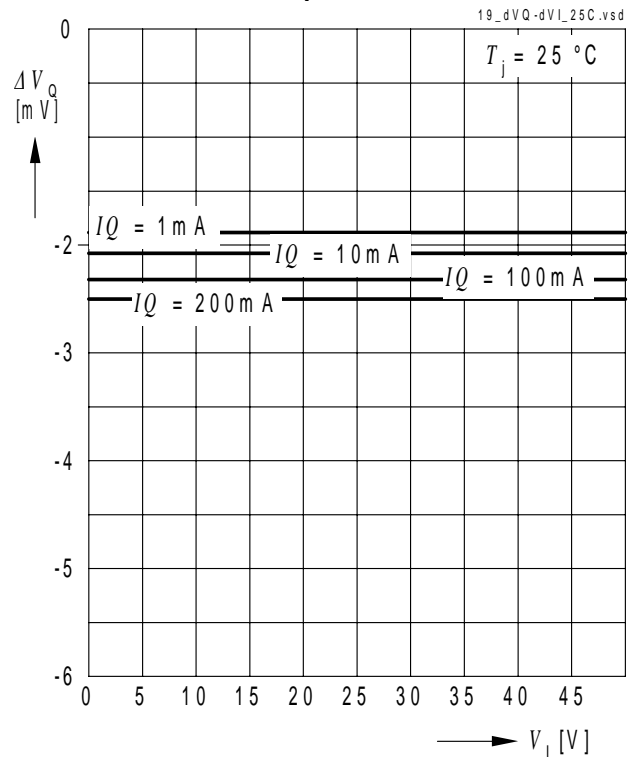

Line Regulation dV_Q versus Input Voltage Changed V_I

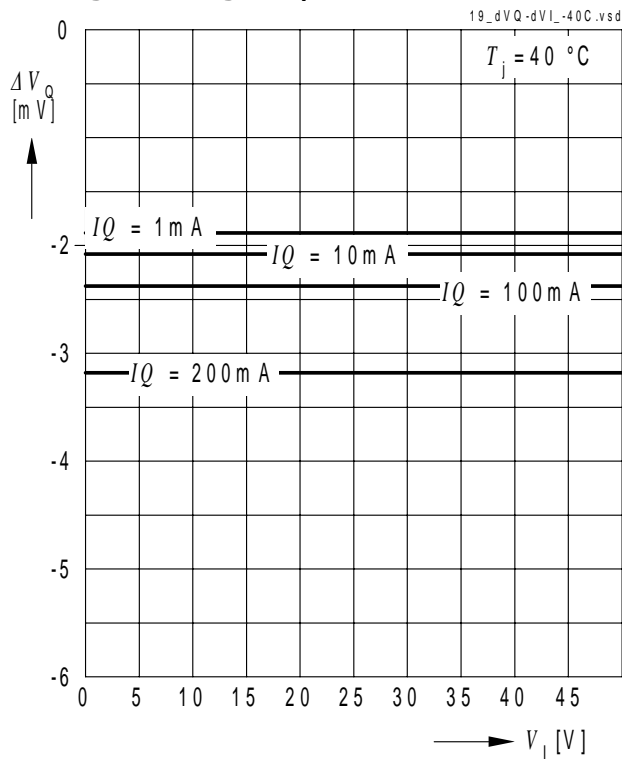

Load Transient Response Peak Voltage dV_Q

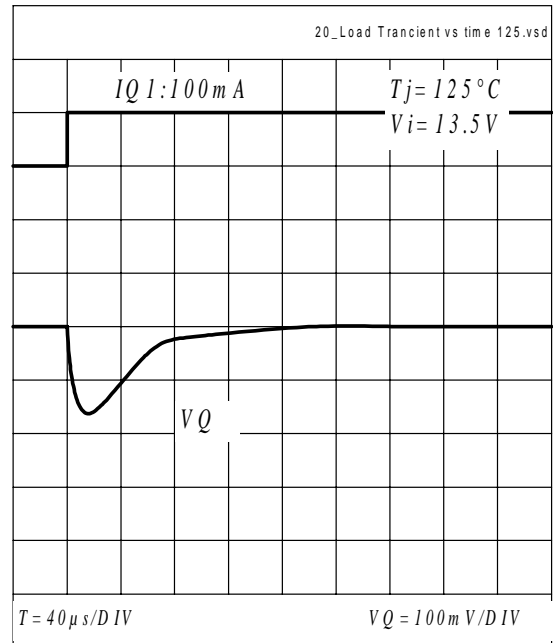

Load Transient Response Peak Voltage dV_Q

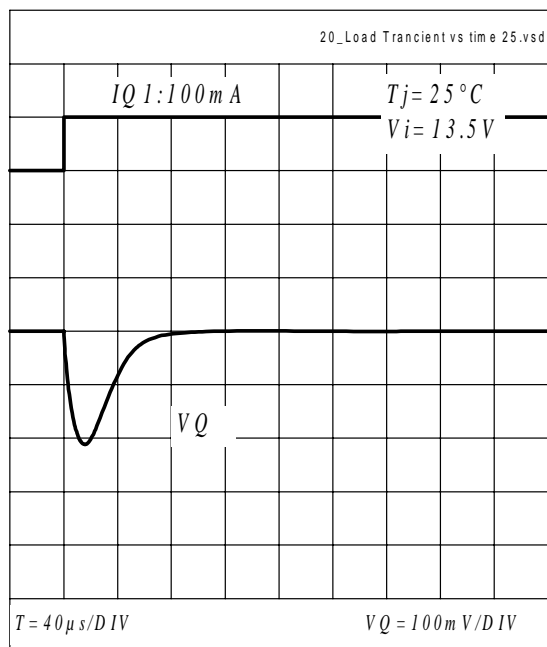

Line Transient Response Peak Voltage dV_Q

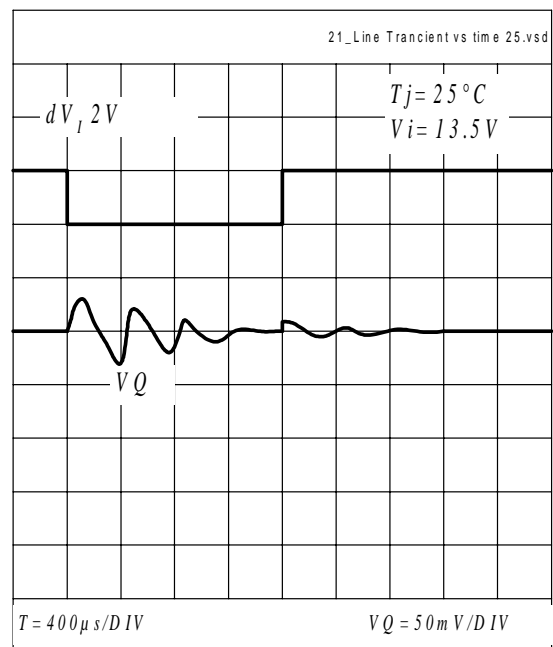

Line Transient Response Peak Voltage dV_Q

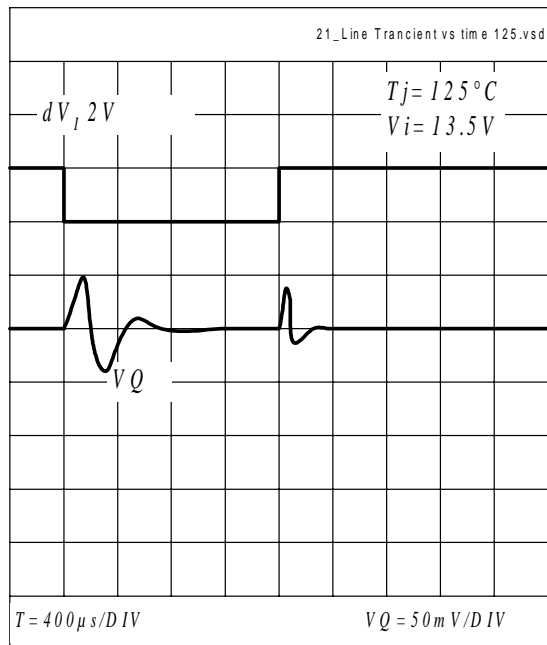

Inhibit Input Current I_{INH} versus Input Voltage V_I , INH=Off

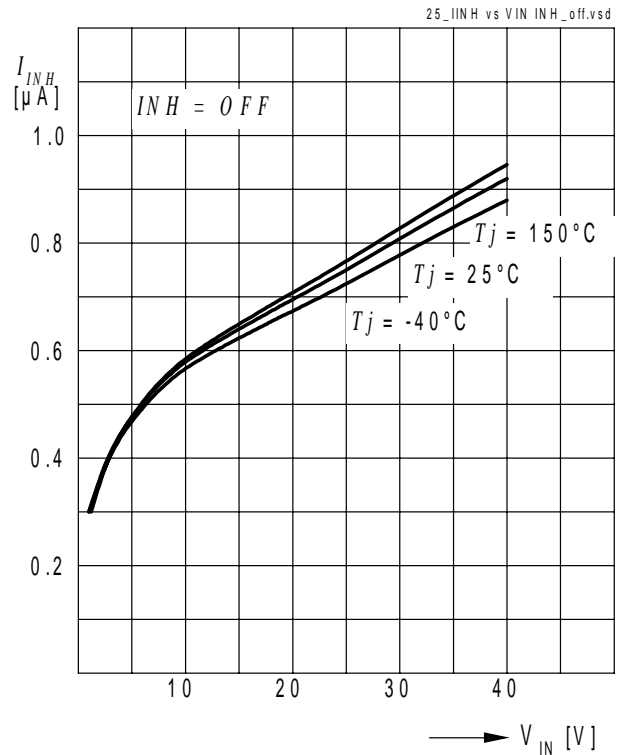

Inhibit Input Current I_{INH} versus Inhibit Input Voltage V_{INH}

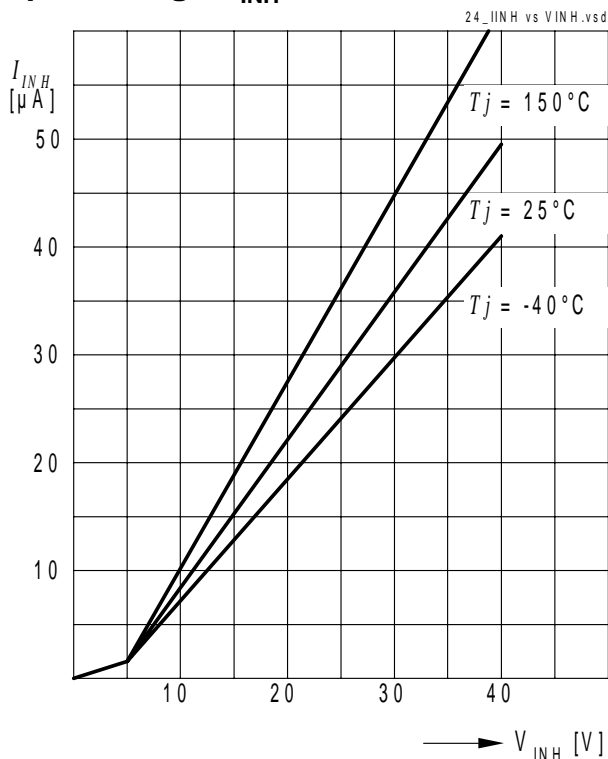

Thermal Resistance Junction-Ambient R_{THJA} versus Power Dissipation P_V

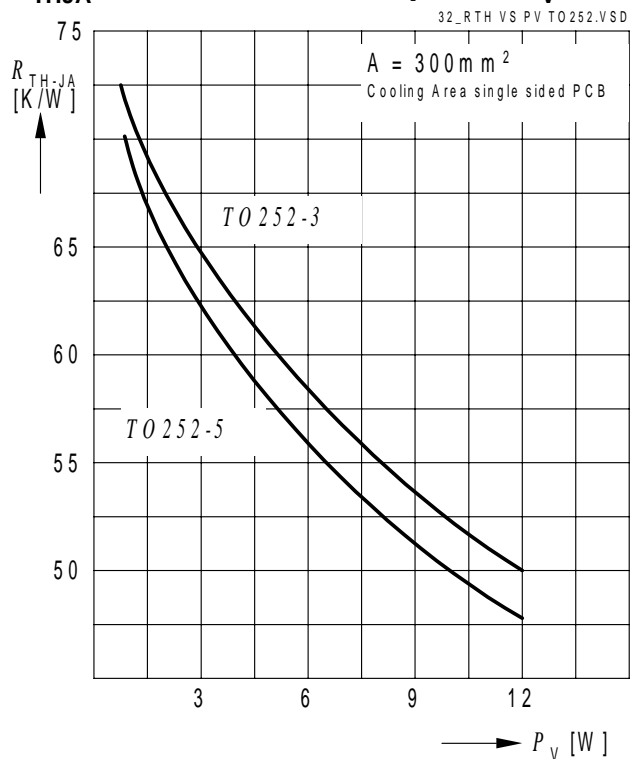

Package Outlines

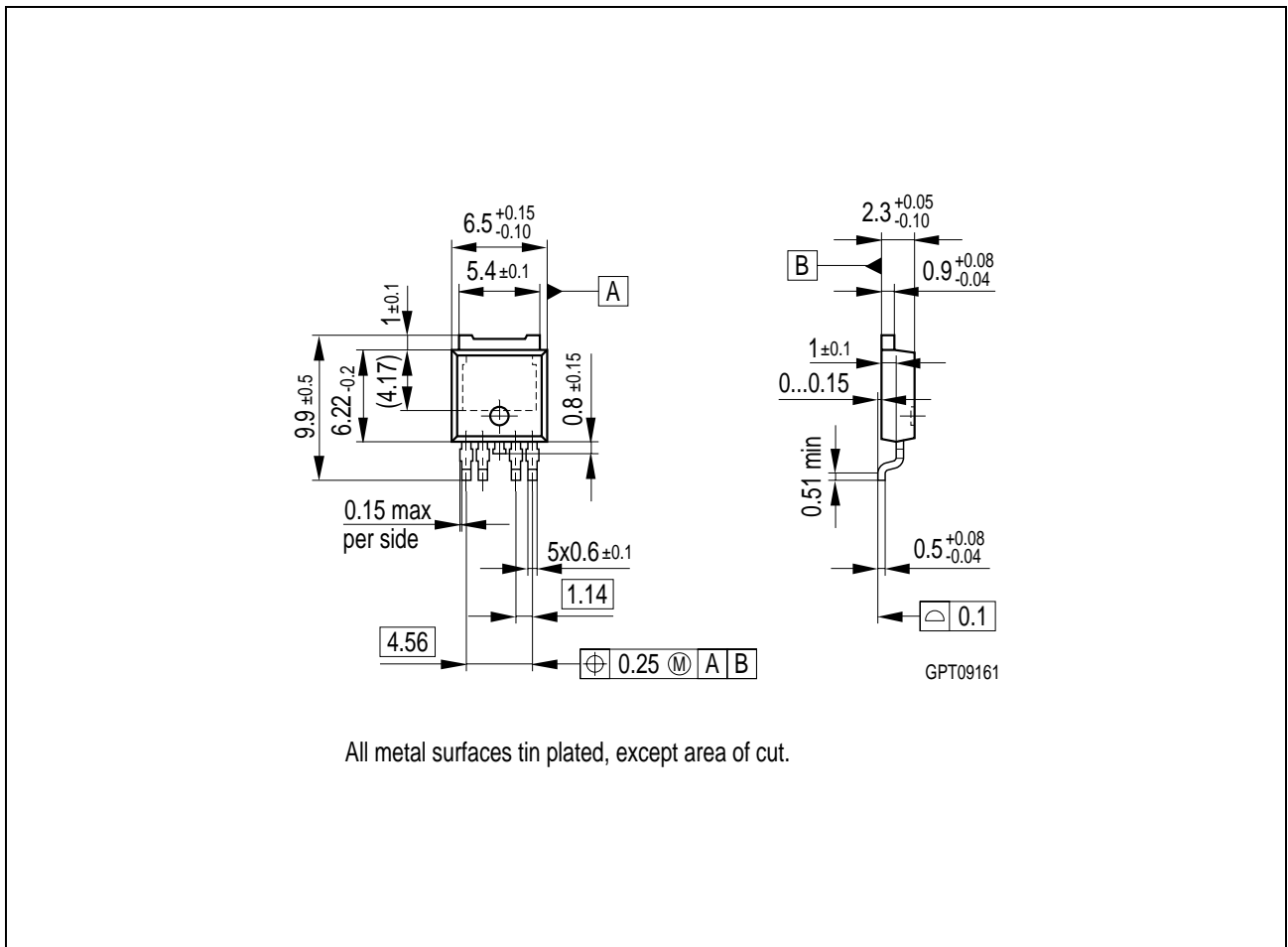

Figure 4 P-TO252-5-1 (Plastic Transistor Single Outline)

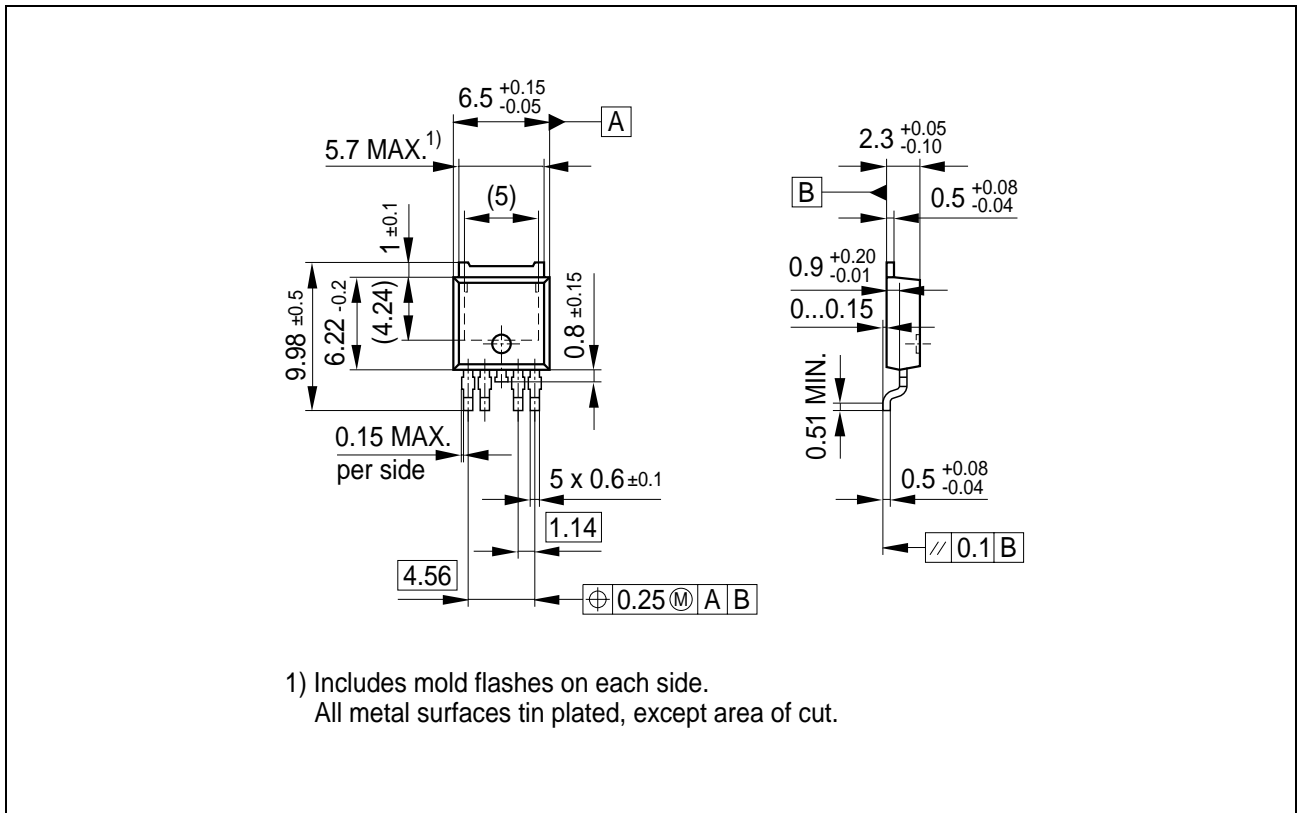

Figure 5 P-TO252-5-11 (Plastic Transistor Single Outline)

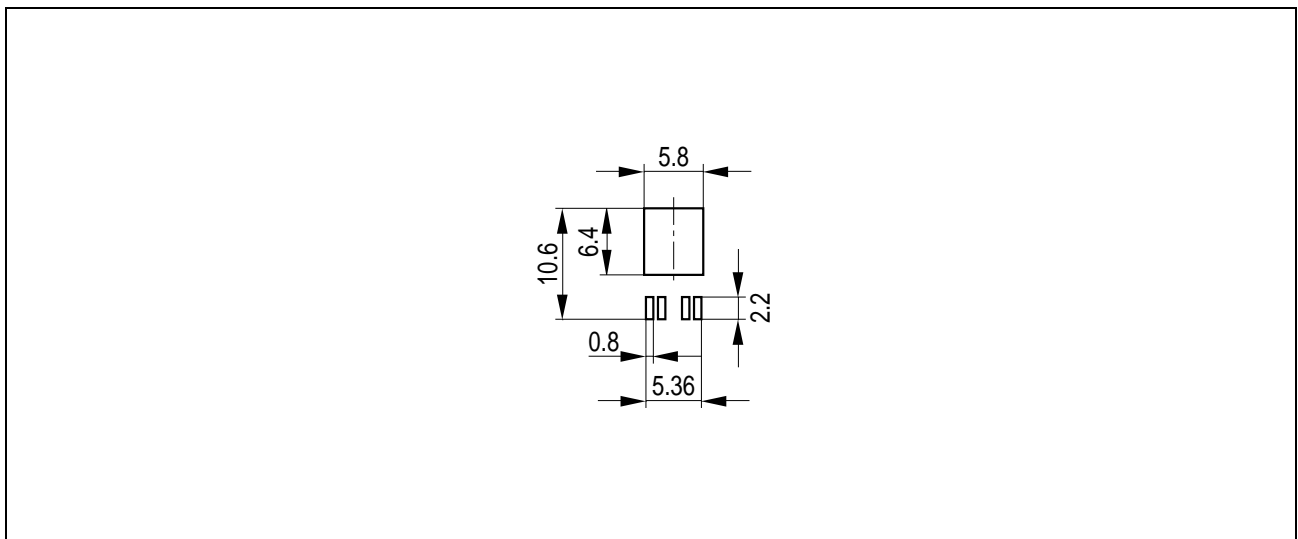

Figure 6 Foot Print for P-TO-252-5-1 and P-TO-252-5-11 (Plastic Transistor Single Outline)

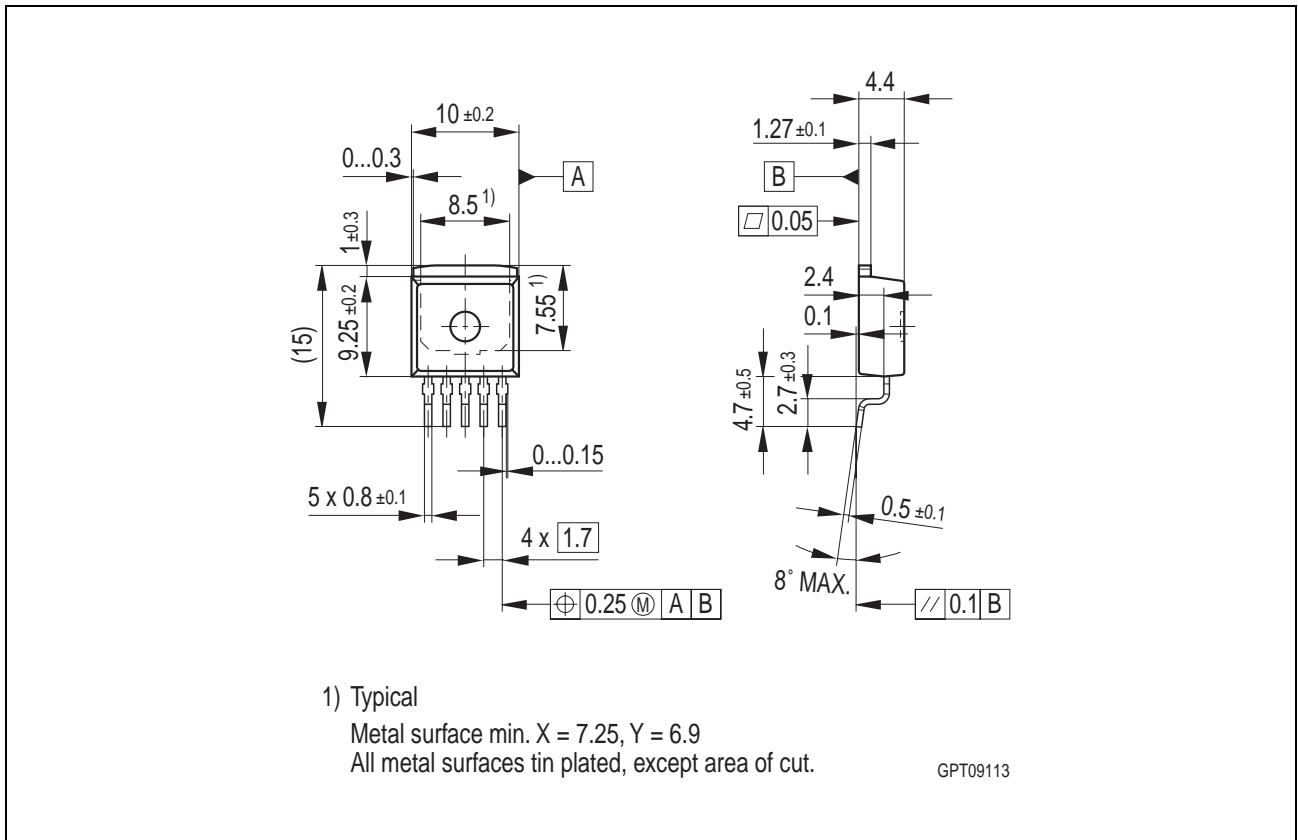

Figure 7 P-TO263-5-1 (Plastic Transistor Single Outline)

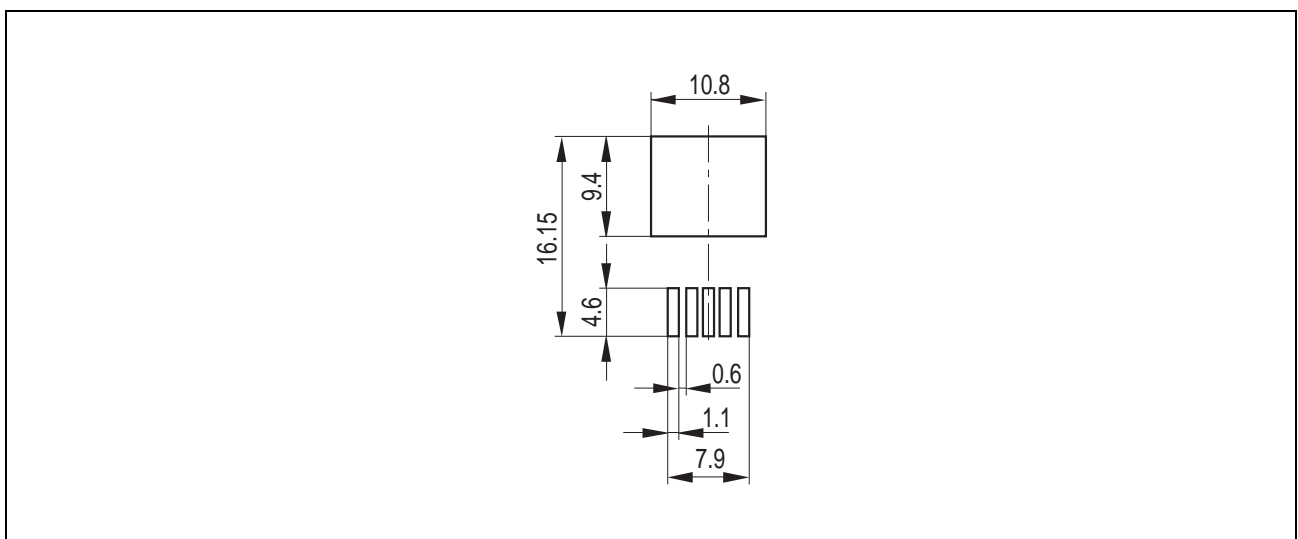

Figure 8 Foot Print for P-TO263-5-1 (Plastic Transistor Single Outline)

You can find all of our packages, sorts of packing and others in our Infineon Internet Page "Products": <http://www.infineon.com/products>.

Dimensions in mm

Remarks

Edition 2005-07-30

**Published by Infineon Technologies AG,
St.-Martin-Strasse 53,
81669 München, Germany**

**© Infineon Technologies AG 2004.
All Rights Reserved.**

Attention please!

The information herein is given to describe certain components and shall not be considered as a guarantee of characteristics.

Terms of delivery and rights to technical change reserved.

We hereby disclaim any and all warranties, including but not limited to warranties of non-infringement, regarding circuits, descriptions and charts stated herein.

Information

For further information on technology, delivery terms and conditions and prices please contact your nearest Infineon Technologies Office (www.infineon.com).

Warnings

Due to technical requirements components may contain dangerous substances. For information on the types in question please contact your nearest Infineon Technologies Office.

Infineon Technologies Components may only be used in life-support devices or systems with the express written approval of Infineon Technologies, if a failure of such components can reasonably be expected to cause the failure of that life-support device or system, or to affect the safety or effectiveness of that device or system. Life support devices or systems are intended to be implanted in the human body, or to support and/or maintain and sustain and/or protect human life. If they fail, it is reasonable to assume that the health of the user or other persons may be endangered.